



# 8" (205 mm) Benchtop Bandsaw

BS-B200H MANUAL

[CARBATEC.COM.AU](http://CARBATEC.COM.AU)

carbatec®

**1** YEAR  
WARRANTY

# THANK YOU FOR CHOOSING carbatec®

Carbatec has been a trusted brand for woodworking enthusiasts and professionals across Australia and New Zealand, since 1987.

Our quality woodworking products are designed and built to offer value and performance, making the latest features and technological advancements more accessible to Aussie woodworkers.

Backed by our no-fuss after-sales care and warranty support, you can trust Carbatec to keep you woodworking, as promised.

**We look forward to sharing in your woodworking journey!**

If you have any questions about our products or service, please call us on **1800 658 111** or email us at [info@carbatec.com.au](mailto:info@carbatec.com.au)

#### Find us on social media



[facebook.com/Carbatec](https://facebook.com/Carbatec)



[instagram.com/Carbatec](https://instagram.com/Carbatec)



[youtube.com/CarbaTecToolsForWood](https://youtube.com/CarbaTecToolsForWood)

# WHAT'S IN THE BOX

The following items are provided in the shipping box:

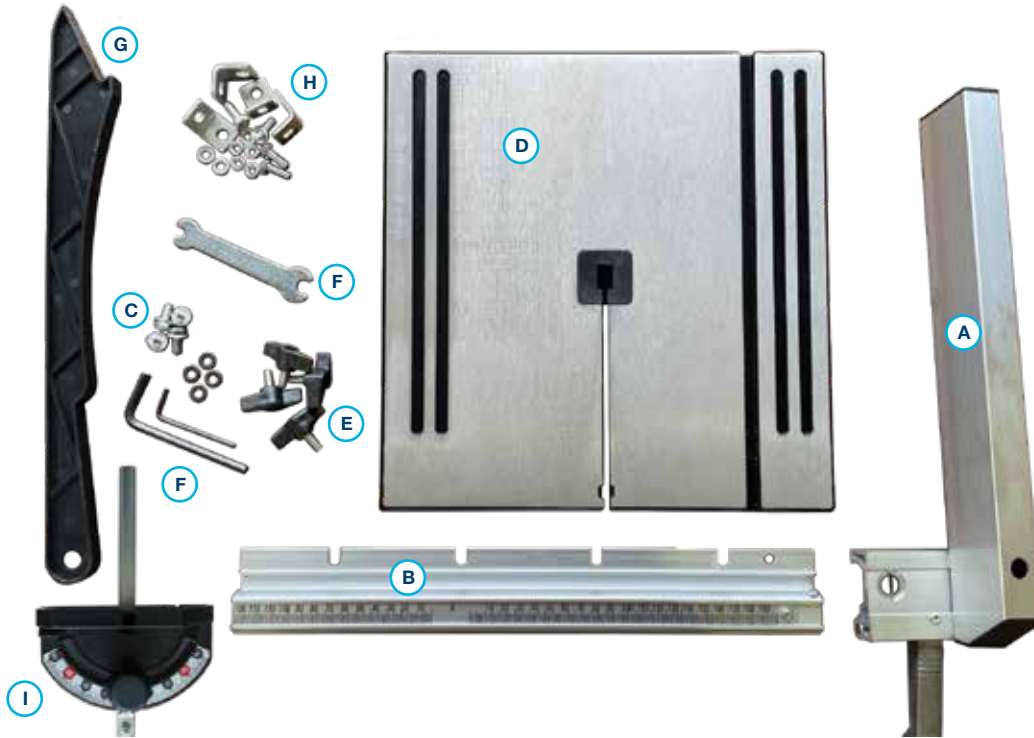

## BS-B200H 8" BANDSAW

A. Fence	D. Alloy table	G. Push stick
B. Front fence rail	E. Fence mounting knobs	H. Bench brackets and bolts
C. Table mounting bolts	F. Tools	I. Mitre gauge

This bandsaw will require a minimal amount of assembly.

### ! CAUTION

1. Remove parts from all of the cartons and lay them on a clean work surface.

**DO NOT USE ACETONE**, gasoline or lacquer thinner to remove any protective coatings.

2. Remove any protective materials and coatings from all of the parts and the bandsaw. The protective coatings can be removed by spraying WD-40 on them and wiping it off with a soft cloth.

### ! WARNING

3. Compare the items to verify that all are accounted for before discarding the shipping box.

If any parts are missing, do not attempt to plug in the power cord and turn "ON" the bandsaw. The bandsaw can only be turned "ON" after all the parts have been obtained and installed correctly.

# IMPORTANT

**DUST COLLECTION:** All woodworking machines require effective dust extraction to ensure quality work and longevity of the machine itself. Failure to connect your machine to a suitable dust collector may affect your warranty. The collector required for your machine will depend on several factors including the type of machine and its dust port connection, distance between collector and machine, type & frequency of use and the material being worked. We recommend a dust collector that will provide you a minimum airflow of 500-CFM when measured at the machine connection.

4

Key information can be found on the inspection panel, found on the rear of the machine.

**carbatec**  
 QUALITY INSPECTED

Model:
Voltage
Freq:
Phase:
Amp:
kW:
Speed:
Lot No.:
Serial No.:
Date:

Made for:  
 CARBATEC PTY LTD  
 Brisbane - Australia



Record the serial number and date of purchase in your manual for future reference.

SERIAL NUMBER:

.....

DATE OF PURCHASE:

.....

# CONTENTS

<b>Introduction</b>	<b>2</b>
<b>What's in the box</b>	<b>3</b>
<b>Key information</b>	<b>4</b>
<b>Safety instructions - General</b>	<b>6-9</b>
<b>Safety instructions - Bandsaw</b>	<b>9-10</b>
<b>Safety instructions - Electrical</b>	<b>11</b>
<b>Overview</b>	<b>12</b>
<b>Specifications</b>	<b>13</b>
<b>Assembly</b>	<b>14-17</b>
<b>Setup</b>	<b>18-21</b>
<b>Operation</b>	<b>22-23</b>
<b>Maintenance</b>	<b>24-25</b>
<b>Troubleshooting</b>	<b>26</b>
<b>Wiring diagram</b>	<b>27</b>
<b>Parts diagram/Parts list</b>	<b>28-29</b>
<b>Warranty</b>	<b>30</b>
<b>Notes</b>	<b>31</b>

**NOTE:** The specifications, photographs, drawings and information in this manual represent the current machine model when the manual was prepared. Changes and improvements may be made at any time, with no obligation on the part of Carbatec to modify previously delivered units. Reasonable care has been taken to ensure that the information in this manual is correct, to provide you with the guidelines for the proper safety, assembly and operation of this machine.

# SAFETY INSTRUCTIONS

**IMPORTANT!** Safety is the single most important consideration in the operation of this equipment. The following instructions must be followed at all times. Failure to follow all instructions listed below may result in electric shock, fire, and/or serious personal injury. There are certain applications for which this tool was designed. We strongly recommend that this tool not be modified and/or used for any other application other than that for which it was designed. If you have any questions about its application, do not use the tool until you have contacted us and we have advised you.

The purpose of safety symbols is to attract your attention to possible dangers. The safety symbols and the explanations with them deserve your careful attention and understanding. The symbol warnings do not, by themselves, eliminate any danger. The instructions and warnings they give are no substitutes for proper accident prevention measures.

## **WARNING**

Be sure to read and understand all safety instructions in this manual, including all safety alert symbols such as "DANGER," "WARNING," and "CAUTION" before using this tool. Failure to following all instructions listed below may result in electric shock, fire, and/or serious personal injury.

## SYMBOL MEANING



A safety alert symbol Indicates **DANGER**, **WARNING**, or **CAUTION**. May be used in conjunction with other symbols or pictographs.



**DANGER**

Indicates an imminently hazardous situation, which, if not avoided, will result in death or serious injury.



**WARNING**

Indicates a potentially hazardous situation, which, if not avoided, could result in death or serious injury.



**CAUTION**

Indicates a potentially hazardous situation, which, if not avoided, could result in minor or moderate injury.

**NOTICE**

(Without Safety Alert Symbol) Indicates a situation that may result in property damage.



Carbatec products bearing the Regulatory Compliance Mark (RCM) have been tested in accordance with applicable Australian/New Zealand Standards to ensure their compliance with all mandatory standards and regulations (applicable at time of original sale). Carbatec Pty Ltd are registered as a responsible supplier with relevant Australian government departments and our products are registered on the EESS & ACMA database.

# GENERAL SAFETY

Operating a power tool can be dangerous if safety and common sense are ignored. The operator must be familiar with the operation of this machine. Read this manual to understand this machine. **DO NOT OPERATE** this machine **IF YOU DO NOT FULLY UNDERSTAND** the limitations of this tool. **DO NOT MODIFY** this machine in any way.

## BEFORE USING THIS MACHINE

### WARNING

To avoid serious injury and damage to the tool, read and follow all of the Safety and Operating Instructions before operating the machine.

### WARNING

- SOME DUST CREATED BY USING POWER TOOLS CONTAINS CHEMICALS** known to cause cancer, birth defects, or other reproductive harm. Some examples of these chemicals are:
  - Lead from lead-based paints.
  - Crystalline silica from bricks, cement, and other masonry products.
  - Arsenic and chromium from chemically treated lumber

Your risk from these exposures varies, depending on how often you do this type of work. To reduce your exposure to these chemicals: work in a well ventilated area and work with approved safety equipment, such as those dust masks that are specially designed to filter out microscopic particles.

- READ** this entire manual. **LEARN** how to use the tool for its intended applications.

- GROUND ALL TOOLS.** If the tool is supplied with a 3-prong plug, it must be plugged into a 3-contact electrical receptacle. The third prong is used to ground the tool and provide protection against accidental electric shock.
- AVOID A DANGEROUS WORKING ENVIRONMENT.** Do not use electrical tools in a damp environment or expose them to rain.
- DO NOT USE** electrical tools in the presence of **FLAMMABLE** liquids or gases.
- ALWAYS KEEP THE AREA CLEAN,** well lit, and organized. Do not work in an environment with floor surfaces that are slippery from debris, grease, and wax.
- KEEP VISITORS AND CHILDREN AWAY.** Do not permit people to be in the immediate work area, especially when the electrical tool is operating.
- DO NOT FORCE THE TOOL** to perform an operation for which it was not designed. It will do a safer and higher quality job by only performing operations for which the tool was intended.
- WEAR PROPER CLOTHING.** Do not wear loose clothing, gloves, neckties, or jewellery. These items can get caught in the machine during operations and pull the operator into the moving parts. The user must wear a protective cover on their hair, if hair is long, to prevent it from contacting any moving parts.
- CHILDPROOF THE WORKSHOP AREA** by removing switch keys, unplugging tools from the electrical receptacles, and using padlocks.

## GENERAL SAFETY

- 11. ALWAYS UNPLUG THE TOOL FROM THE ELECTRICAL RECEPTACLE**  
when making adjustments, changing parts or performing any maintenance.
- 12. KEEP PROTECTIVE GUARDS IN PLACE AND IN WORKING ORDER.**
- 13. AVOID ACCIDENTAL STARTING.** Make sure that the power switch is in the "OFF" position before plugging in the power cord to the electrical receptacle.
- 14. REMOVE ALL MAINTENANCE TOOLS** from the immediate area prior to turning "ON" the machine.
- 15. USE ONLY RECOMMENDED ACCESSORIES.** Use of incorrect or improper accessories could cause serious injury to the operator and cause damage to the tool. If in doubt, check the instruction manual that comes with that particular accessory.
- 16. NEVER LEAVE A RUNNING TOOL UNATTENDED.** Turn the power switch to the "OFF" position. Do not leave the tool until it has come to a complete stop.
- 17. DO NOT STAND ON A TOOL.** Serious injury could result if the tool tips over, or you accidentally contact the tool.
- 18. DO NOT STORE ANYTHING ABOVE OR NEAR** the tool where anyone might try to stand on the tool to reach it.
- 19. MAINTAIN YOUR BALANCE.** Do not extend yourself over the tool. Wear oil resistant rubber soled shoes. Keep floor clear of debris, grease, and wax.
- 20. MAINTAIN TOOLS WITH CARE.** Always keep tools clean and in good working order. Keep all blades and tool bits sharp, dress grinding wheels and change other abrasive accessories when worn.
- 21. EACH AND EVERY TIME, CHECK FOR DAMAGED PARTS PRIOR TO USING THE TOOL.** Carefully check all guards to see that they operate properly, are not damaged, and perform their intended functions. Check for alignment, binding or breaking of moving parts. A guard or other part that is damaged should be immediately repaired or replaced.
- 22. DO NOT OPERATE TOOL WHILE TIRED, OR UNDER THE INFLUENCE OF DRUGS, MEDICATION OR ALCOHOL.**
- 23. SECURE ALL WORK.** Use clamps or jigs to secure the work piece. This is safer than attempting to hold the work piece with your hands.
- 24. STAY ALERT, WATCH WHAT YOU ARE DOING, AND USE COMMON SENSE WHEN OPERATING A POWER TOOL.** A moment of inattention while operating power tools may result in serious personal injury.
- 25. ALWAYS WEAR A DUST MASK TO PREVENT INHALING DANGEROUS DUST OR AIRBORNE PARTICLES,** including wood dust, crystalline silica dust and asbestos dust. Direct particles away from face and body. Always operate tool in well ventilated area and provide for proper dust removal. Use dust extraction system wherever possible. Exposure to dust may cause serious and permanent respiratory or other injury, including silicosis (a serious lung disease), cancer, and death. Avoid breathing dust, and



avoid prolonged contact with dust. Allowing dust to get into your mouth or eyes, or lay on your skin may promote absorption of harmful material. Always use properly fitting AS/NZS approved respiratory protection appropriate for the dust exposure, and wash exposed areas with soap and water.

- 26. USE A PROPER EXTENSION CORD IN GOOD CONDITION.** Use of extension cords should be avoided where possible. When using an extension cord, be sure to have a cord heavy

enough to carry the current your product will draw, and with compatible pin configuration and connections. **NEVER** use an extension cord rated at less than your machine.

Longer run extensions will need heavier duty extension cords. Only connect your extension cord or machine to a receptacle that accepts your plug and never modify your plug to suit a receptacle.

## BANDSAW SAFETY



### WARNING

**The device and packaging materials are not toys! Children must not be allowed to play with plastic bags, film and small parts! There is a risk of swallowing and suffocation!**

**NOTE:** According to the applicable product liability law the manufacturer of this device is not liable for damages which arise on or in connection with this device in case of:

- Improper handling
- Non-compliance with the instructions for use
- Repairs by third party, non authorised skilled workers
- Installation and replacement of non-genuine spare parts
- Improper use

### RECOMMENDATIONS:

- Read the entire text of the operating instructions prior to the assembly and operation of the device. These operating instructions are intended to make it easier for you to get familiar with your device and utilise its intended possibilities of use.
- The operating instructions contain important notes on how to work safely with your machine and how to avoid dangers, and increase the reliability and working life of the machine.
- Retain and store these instructions near the machine. The instructions must be read and carefully observed by each operator prior to starting the work.
- In addition to the safety notes contained in the present operating instructions and the special regulations of your country, the generally recognised technical rules for the operation of wood working machines must be observed.

# BANDSAW SAFETY

## INTENDED USE

- The machine must only be used in technically perfect condition in accordance with its designated use and the instructions set out in the operating manual, and only by safety-conscious persons who are fully aware of the risks involved in operating the machine. Any functional disorders, especially those affecting the safety of the machine, should therefore be rectified immediately. The safety, work and maintenance instructions of the manufacturer as well as the technical data given in the calibrations and dimensions must be adhered to.
- Relevant accident prevention regulations and other, generally recognised safety-technical rules must also be adhered to.
- The machine may only be used, maintained, and operated by persons familiar with it and instructed in its operation and procedures. Arbitrary alterations to the machine release the manufacturer from all responsibility for any resulting damages.
- The machine may only be used with original accessories and tools made by or recommended by the manufacturer
- Any other use exceeds authorisation. The manufacturer is not responsible for any damages resulting from unauthorized use; risk is the sole responsibility of the operator.

## SAFETY FOR BANDSAWS

- This bandsaw is intended for use in dry conditions, and for indoor use only.
- Do not cut pieces of material too small to hold by hand outside the blade guard.
- Avoid awkward hand positions where a sudden slip could cause a hand to move into the blade.

- Always use the blade guard to avoid possible injury due to blade breakage.
- Never leave the work area with the power connected, or before the machine has come to a complete stop.
- Do not perform layout, assembly or set up work on the table while the cutting tool is in operation.
- Never turn your bandsaw on before clearing the table of all objects: (tools, scraps of wood, etc) except for the workpiece and related feed or support devices for the operation planned.

## REMAINING HAZARDS

The machine has been built using modern technology in accordance with recognised safety rules. Some remaining hazards, however, may still exist.

- Long hair and loose clothing can be hazardous. Wear personal protective gear such as a hair net and tight fitting work clothes.
- Saw dust and wood chips can be hazardous. Always wear AS/NZS approved personal protective gear such as safety goggles, dust mask and hearing protection.
- The use of incorrect or damaged mains cables can lead to injuries caused by electricity.
- Even when all safety measures are taken, some remaining hazards which are not yet evident may still be present.
- Remaining hazards can be minimised by following the instructions in Safety Precautions, Proper Use and in the entire operating manual.
- Do not force the machine unnecessarily: excessive cutting pressure may lead to rapid deterioration of the blade and a decrease in performance in terms of finish and cutting precision.

# ELECTRICAL SAFETY

## WARNING

**This tool must be grounded while in use to protect the operator from electric shock. IN THE EVENT OF A MALFUNCTION OR BREAKDOWN,** grounding provides the path of least resistance for electric current and reduces the risk of electric shock. This tool may be equipped with an electric cord that has an equipment grounding conductor and a grounding plug. **The plug MUST Be plugged** into a matching electrical receptacle that is properly installed and grounded in accordance with **ALL** local codes and ordinances.

### **DO NOT MODIFY THE PLUG PROVIDED.**

If it will not fit the electrical receptacle, have the proper electrical receptacle installed by a qualified electrician.

**IMPROPER ELECTRICAL CONNECTION** of the equipment grounding conductor can result in risk of electric shock. The conductor with the green insulation (with or without yellow stripes) is the equipment grounding conductor. **DO NOT** connect the equipment grounding conductor to a live terminal if repair or replacement of the electric cord or plug is necessary.

### **CHECK WITH A QUALIFIED ELECTRICIAN**

or service personnel if you do not completely understand the grounding instructions, or if you are not sure the tool is properly grounded.

**Use only a 3-wire extension cord that has a 3-prong grounding plug and a 3-pole receptacle that accepts the tool's plug. Replace a damaged or worn cord immediately.**

Power tools and machinery are intended for use on a circuit that has an electrical receptacle as shown in **FIGURE A** that shows a 10 Amp 3-wire electrical plug and corresponding electrical receptacle that has a grounding conductor.

If this particular tool has been designed and fitted with a two prong electrical plug, ensure it displays the 'Double Insulated' logo shown in **FIGURE B**, before connecting to a 3-wire receptacle.

## WARNING

**Never modify the standard fitted electrical plugs to fit your receptacle.**



# OVERVIEW

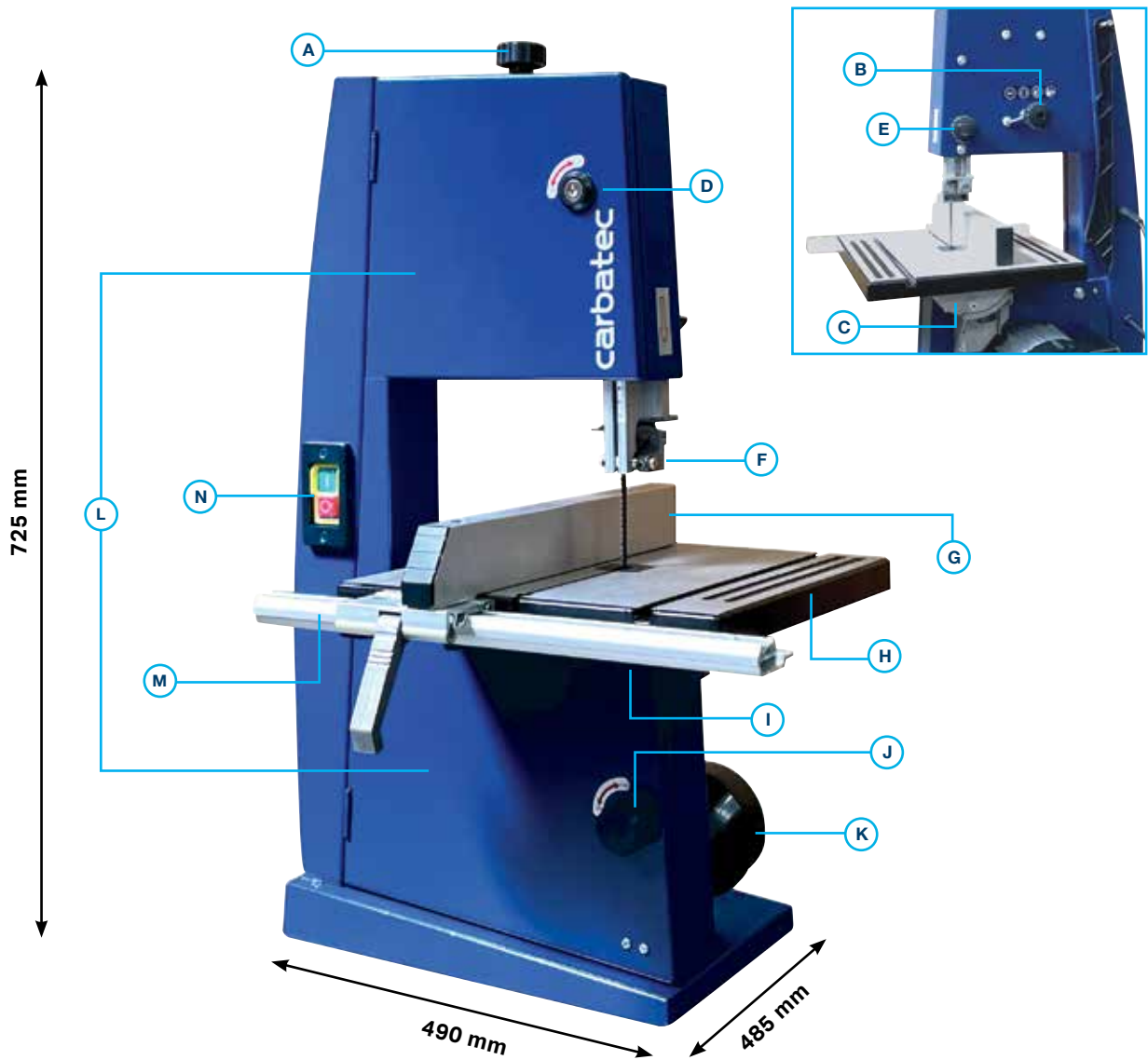

## BS-B200H 8" (200MM) BENCHTOP BANDSAW

- |   |                                    |
|---|------------------------------------|
| <b>A.</b> Blade tension knob                    | <b>H.</b> Alloy table              |
| <b>B.</b> Blade tracking and locking knobs      | <b>I.</b> Bottom blade guide       |
| <b>C.</b> Table tilt trunnion                   | <b>J.</b> Bottom door lock         |
| <b>D.</b> Top door lock                         | <b>K.</b> 4" Dust port             |
| <b>E.</b> Blade guard lock and adjustment knobs | <b>L.</b> Top & bottom door access |
| <b>F.</b> Top blade guide                       | <b>M.</b> Fence rail               |
| <b>G.</b> Fence                                 | <b>N.</b> On/off switch            |

# SPECIFICATIONS

<b>CODE</b>	BS-B200H
<b>MOTOR</b>	370 W (½ HP) induction - regular 10 A plug
<b>SWITCH TYPE</b>	Magnetic NVR
<b>BLADE GUIDES</b>	Euro style with rack and pinion rise and fall
<b>BLADE LENGTH</b>	1490 mm
<b>BLADE RELEASE</b>	Standard tension release knob
<b>BLADE SPEED</b>	880 m/min
<b>DEPTH OF CUT</b>	100 mm
<b>DUST PORT</b>	1 × 100 mm (4")
<b>MINIMUM BLADE WIDTH</b>	3.2 mm (⅛")
<b>MAXIMUM BLADE WIDTH</b>	12 mm (½")
<b>MAXIMUM RIP CAPACITY</b>	195 mm
<b>POSITIVE STOPS</b>	0° (adjustable)
<b>TABLE HEIGHT</b>	315 mm
<b>TABLE SIZE</b>	300 × 310 mm
<b>TABLE TILT</b>	+ 45°
<b>WORKSHOP FOOTPRINT (W×D×H)</b>	485 × 490 × 725 mm
<b>WHEEL DIAMETER</b>	204 mm
<b>WHEEL TYPE</b>	Cast alloy
<b>WARRANTY PERIOD</b>	1 year
<b>SHIPPING WEIGHT</b>	20.5 kg
<b>NETT WEIGHT</b>	18.5 kg

# ASSEMBLY

## A. TABLE ASSEMBLY

1. With the machine safely placed on a flat, stable surface such as a workbench, tilt the trunnion to 30° and lock it in place.

**Fig. A1**



2. Slide the table into approximate position ensuring the blade passes through the slot, with the table opening facing to the front of the machine.

**Fig. A2**



3. Insert the table mounting bolts and washers into the matching threaded holes in the table, from underneath. The table is tilted to provide easier access to all bolt holes. Finger tighten all bolts, leaving them just loose enough to adjust the table.

**Fig. A3**



4. Using a ruler or straight edge, align the table slot to be parallel with the blade by slightly rotating the loose table.

**Fig. A4**





5. Once you are happy with the alignment, go ahead and tighten all the table bolts with the spanner provided. You can then adjust the tilt of the table back to 0°.

**Fig. A5**

6. The blade needs to run through the middle of the table insert. If required, you can adjust this by loosening the three trunnion mounting bolts on the back of the machine two turns each, sliding the assembly into position and re-tightening.

**Fig. A6**

7. The next step is to assemble the fence. Screw the fence rail wing nuts (x4) into the threaded holes at the front edge of the table. Leave approximately 5 mm unthreaded on each bolt.

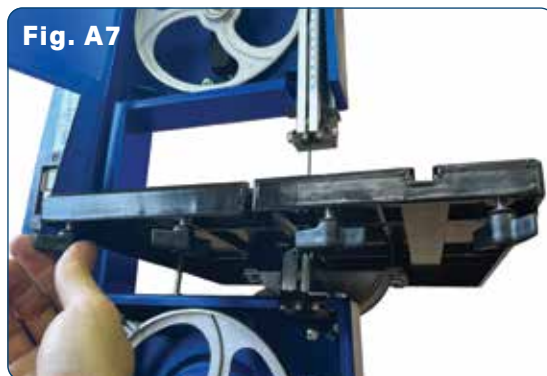
**Fig. A7**

8. Slide the fence rail into position, in the gap you left on the wing nuts and finger tighten, ensuring the rail is pressed against the front of the table.

**Fig. A8**

# ASSEMBLY

9. Place the fence onto the rail to the left of the blade. The fence needs to be parallel to the table slot/mitre track. If necessary, this can be adjusted via two Allen bolts, one through the hole in the top face of the fence; the other under the black plastic end cap which can be popped off for access. Simply loosen, adjust the fence angle slightly as required and re-lock.

**Fig. A9**



10. Move the fence and set the hairline magnifier to "0" on the left of the blade, locking the fence in this position.

**Fig.10**



11. Loosen and slide the rail slightly as required, so the face of the fence is flush with the set of the teeth on the blade, without pushing on the blade itself.

**Fig. A11**



12. If you have moved the fence rail as far as its adjustment will go, but the fence does not reach the blade on the "0" setting, you can adjust the position of the rail scale with a Philips screwdriver. Undo the small bolt on the right side of the fence rail scale a few turns, slide the scale until you are able to zero the fence to the blade and re-tighten.

**Fig. A12**





13. Check the table is set at 90° (square) to the blade, using a quality square. If necessary adjust the tilt on the trunnion and lock in place.

**Fig. A13**



14. Ensure your "pointer" on the trunnion scale is accurately pointing to "0" in this position. Adjust with a Philips head screwdriver if required.

**Fig. A14**



15. The bandsaw is fitted with an adjustable stop, allowing you to easily return the table to 90° when required. With the table currently locked at exactly 90°, loosen the nuts on the bolt below the table and turn the screw until the head is resting against the underside of the table. Now lock this into position with the nut.

**Fig. A15**

\*NB: this "zero stop" setting will prevent you from tilting the table in the opposite direction (-), unless you wind it out of the way.

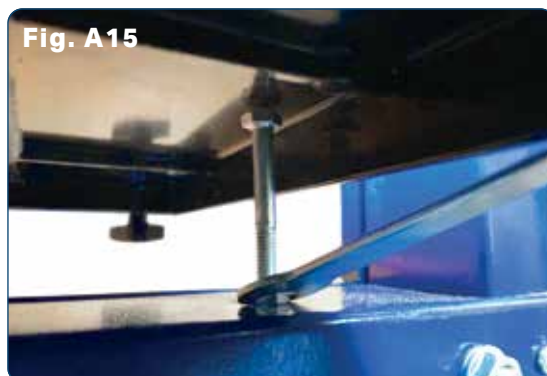

16. Finally, the bandsaw includes some bench mounting brackets and bolts. If desired, you can now attach the brackets to the machine with the bolts provided, in the holes at the base of the machine. You can then screw these brackets down to your bench. This provides the ultimate in stability for your machine, at the expense of being able to move it out of the way easily.

**Fig. A16**



# SETUP



## DANGER

Ensure power is disconnected from your machine before undertaking any adjustments or alignment.

### B. SETTING UP THE BANDSAW

1. Using the Allen key provided, unlock the top door by rotating a quarter turn anti-clockwise. This machine requires a "tool" (Allen key) to open the door to meet CE and school/business safety specification requirements.

**Fig. B1**

2. Turn the knob on the bottom door in an anti-clockwise direction to unthread the retaining bolt. Note that this bolt is long! This long thread holds the door assembly closed and engages the micro-switch on the door.

**Fig. B2**

3. Open the door and place a block in front of it to hold it open. This will allow you to readily access the adjustments required to properly setup your bandsaw.

4. Tension and track the blade on the upper wheel. To do so without impediment, loosen the blade guides so they are well clear of the blade for now. Using the Allen key provided, go ahead and loosen all guide and thrust bearings, moving them away from the blade.

**Fig. B3 and B4**



5. Adjust the blade tension by turning the knob located on the top of the bandsaw. Clockwise rotation will increase tension, anti-clockwise will reduce tension.

**Fig. B5**

6. Correct tension is applied when a deflection of approximately 5 mm is achieved with moderate finger pressure, in the centre of the blade (hence the guides being out of the way). Note that this is an approximate setting only. Correct tension will vary by blade size and type, spring tension wear and other factors.

**Fig. B6**

7. Once you have the tension set, the tracking will need adjustment. Loosen the tracking lock knob on the back of the machine.

**Fig. B7**

8. Hand-rotate the upper wheel very slowly. The blade will either move towards the back of the wheel or the front. Care is required here as the blade can run right off the wheel if considerable adjustment in the blade tension was required. If this occurs, you will need to loosen the upper wheel, place the blade back on the upper and lower wheels and go through the blade tension process again.

**Fig. B8**

# SETUP

9. To adjust the blade tracking, turn the tracking knob on the rear of the machine. Clockwise will move the blade towards the front of the tyre, anti-clockwise towards the back.

**Fig. B9**



10. The aim is to have the blade tracking on the crown of the tyre, that is the middle of the wheel. Once achieved, tighten the blade tracking lock knob again.

**Fig. B10**



11. The European style blade guides can now be set. Below the table, adjust the side guides so they are behind the set of the teeth, where they will guide the flat of the blade. Bring them in to the blade until they just barely miss. A rule-of-thumb here is a "piece of paper" thickness away from the blade. Once in position, lock these in place.

**Fig. B11**



12. The thrust guide is the one which sits behind the blade to assist in pushing the blade backward during cutting. Again, this needs to be positioned a fraction behind the blade, effectively so it is not touching when the machine is turned on alone, but is engaged when in use.

**Fig. B12**





13. The upper blade guides can now be set in the same fashion. The thrust guide just behind the blade.

**Fig. B13**

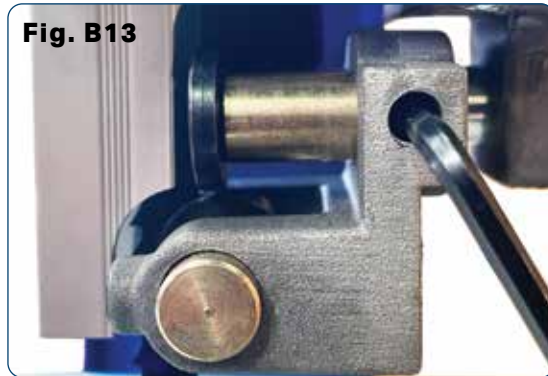

14. And the upper side guides in as close as possible without touching. Ensure the depth of the side guides is such that it does not contact the set of the teeth, but rests slightly behind against the flat of the blade.

**Fig. B14**

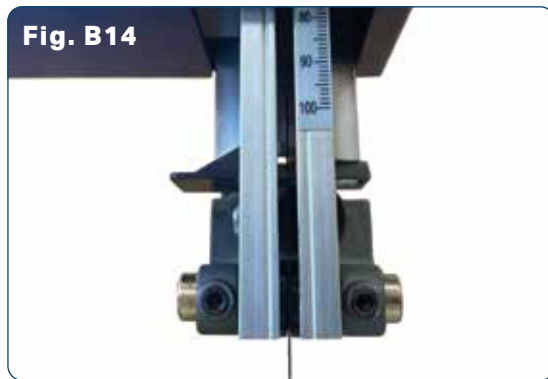

15. Be aware that the Euro Style blade guides present a disc to the blade on the flat face. However, these are on a shaft that is loose inside the housing in order to allow them to rotate freely under load, much like a bearing. Ensure when you are setting the upper or lower guides, that the internal shaft with disc face is seated as far into the housing as possible, to avoid a "false setting".

**Fig. B15**



# OPERATION

## C. HOW TO USE

The purpose of this overview is to provide the novice machine operator with a basic understanding of how the machine is used during operation.

**CAUTION**

**DANGER**

**If you are not experienced with this type of machine, we strongly recommend that you seek additional training outside of this manual. Read books, watch videos or get formal training before beginning any projects.**

1. This machine features a simple ON (green) / OFF (red) Magnetic No-Volt Release (NVR) switch. This means power is required for the switch to be "on". In the event of a power-outage during use, the machine will NOT restart automatically when power is re-established, even if you have forgotten to turn it "off". This is a safety feature of NVR switching.

**Fig. C1**

2. The first adjustment necessary for any operation is your blade guard height setting. Unlock the blade guard lock knob by turning it anti-clockwise.

**Fig. C2**

3. The machine blade guard is geared. Rotate the blade guard height adjustment knob anti-clockwise to move it down, or clockwise to move it up. You should set the height of your guarding to be approximately 5 mm above the maximum thickness of the material you are about to cut.

**Fig. C3 & C4**

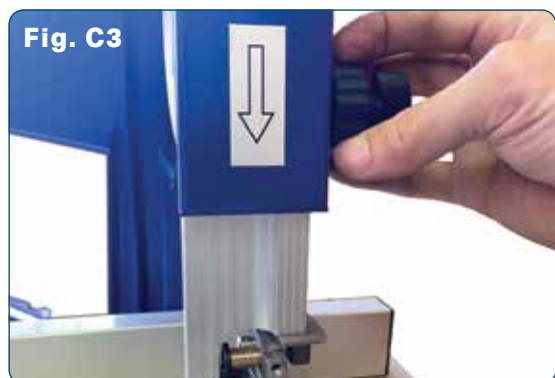

4. Rip cuts can be achieved at fixed depths by using the fence. Simply unlock the fence, slide to the desired rip width and lock it down. Turn the machine on with the material to be cut clear of the blade, then feed the material into the blade slowly, while pressing against the fence. Use appropriate PPE (push blocks, push sticks, ear and eye protection, dust extraction and dust masks where required).

**Fig. C5**

5. Rip cuts can also be done at any desired angle to 45°, with the fence set on the right side of the blade. Note that your blade guard needs to be set to avoid contact with the high point of your cut.

**Fig. C6**

6. Curve cutting is best undertaken with narrow blades and the rip fence removed from the table so you have the freedom to rotate the piece being cut as required, without obstacle. Ensure your cuts are within the machine capacity.

**Fig. C7**

7. Resawing can be undertaken up to 100 mm in depth. Wider blades with fewer teeth are more suited to this task. The blade guard is set as per other operations, with the fence used to set the desired thickness of the resulting cut. The timber needs to be fed slowly for this task, according to the hardness of the material and the depth of the resaw work being done.

**Fig. C8**

# MAINTENANCE

## D. CHANGING THE BLADE

1. Remove the rip fence. Loosen the fence rail wing-nuts a little. Particularly the three from the right side.

**Fig. D1**



2. The aim is to loosen these wing nuts just enough to enable you to "swivel" the rail off the table, to expose the slot in the table, without having to remove the rail entirely.

**Fig. D2**



3. Loosen the blade using the tensioning knob on top of the machine, enough that the blade is sitting loosely over the wheels. It is also best practice to loosen the blade guides and move them away from the blade.

**Fig. D3**



4. Carefully remove the blade from the machine by guiding it off the upper and lower wheels and through both the slot in the frame and that in the table.

**Fig. D4**



5. Install your replacement blade in reverse order. Refer back to "SETTING UP YOUR BANDSAW" to follow the step by step guide in adjustment for your new blade. This is particularly required if the blade you are replacing with is of a different type/dimension to that which you removed.

**Blade length on this machine is 1490 mm. A wide variety of blades to suit this machine are available from Carbatec - check them out online. The machine accepts blades from 3.2 mm to 12.7 mm (1/8" to 1/2") wide.**



## E. MAINTENANCE SCHEDULE

Maintenance of all woodworking machinery is important to keep them operating at their best, ensuring a long machine life, accurate machining and avoiding unexpected (or potentially dangerous) breakdowns.



### WARNING

**Start by turning the machine off, removing from the power source to prevent accidental restarting.**

- If you have an air compressor, carefully blow any sawdust and other debris away from the band saw. Ensure you are wearing AS/NZS approved PPE (dust mask or respirator, eye protection and hearing protection).
- Remove and treat any rust on steel areas using a liquid rust remover, or other cleaning product (avoid silicone based products that may cause issues with wood finishes later on). Take a clean cloth to wipe any cleaning residue, dirt or dust off the table. When it's dry, apply a surface protectant. Carbatec offer many products for machine cleaning and care.
- Check the cutting edges of the blades and replace if dull. Thoroughly clean the blades with either steel wool or a firm bristle brush if they are rusty or pitch covered, using a rust or pitch remover if required. Depending on the machine, it may be easier to remove the blade/s to do this. Clean any areas that hold or contact the blade (blade guides, tyres, blade seats, bearings and arbor etc). Replace worn components immediately.
- Check all manual or automatic guards, doors, switches and machine interlocks for correct and safe operation. Replace as required.
- Check machine stability and ensure all bolts are tight.
- If unsure about any component, consider having the machine serviced.



### WARNING

Dust exposure created while using machinery may cause cancer, birth defects, or long-term respiratory damage. Always wear goggles and a AS/NZS 1716:2012 compliant approved respirator when working with the dust collection bags or canisters.

# TROUBLESHOOTING

PROBLEM	LIKELY CAUSE(S)	SOLUTION(S)
The machine does not work when switched on.	1. No power supply.	Check the cable for breakage, the fuse and that the cable is plugged in and turned on.
	2. Defective switch.	Return the machine to your local dealer for assessment and repair.
	3. Micro-switch not engaged.	Check the door is properly closed.
The blade does not move with the motor running.	1. The blade tension knob has not been tightened.	Switch off the motor, tighten the blade tension knob and setup procedure.
	2. The blade has come off one or both of the wheels.	Open the hinged door and check. Check tension and blade alignment.
	3. The saw blade has broken.	Replace the blade.
The blade does not cut in a straight line.	1. Fence for cutting not used.	Use a fence.
	2. Too fast feed rate.	Put light pressure on the workpiece. Make sure the blade does not bend.
	3. The blade teeth are dull or damaged.	Try a new blade.
	4. Blade guides not suitably adjusted.	Adjust the blade guides (see setup instructions.)
The blade does not cut, or cuts very slowly.	1. The teeth are dull, caused by cutting hard material or long use.	Replace the blade.
	2. The blade was fitted the wrong way round.	Ensure the teeth are facing to the front of the machine and down in the cutting area.
Burn marks present on wood	1. Blunt saw blade.	Replace the blade.
	2. Wrong blade for the job.	Try a more appropriate blade width/teeth.
Motor overheats easily	1. Overloading the machine.	Ensure the motor is not choked with dust and use the right blade for the job, cutting slowly where required. Allow to cool between jobs.
Motor starts slowly or does not reach full speed/power or makes excessive or unusual noise	1. Voltage too low.	Ensure you have the correct power supply for the machine.
	2. Capacitor damaged.	Return the machine to your local dealer for assessment and repair.
	3. Network is overloaded.	Try switching off unnecessary equipment connected to your power supply.
	4. Motor coils could be damaged.	Return the machine to your local dealer for assessment and repair.
Workpiece pulls away from cut or splinters	1. Excessive cutting pressure/speed or blade not best suited to job at hand.	Ensure your machine is properly set up according to the guide in the manual. Try cutting more slowly or a different blade.

# WIRING DIAGRAM

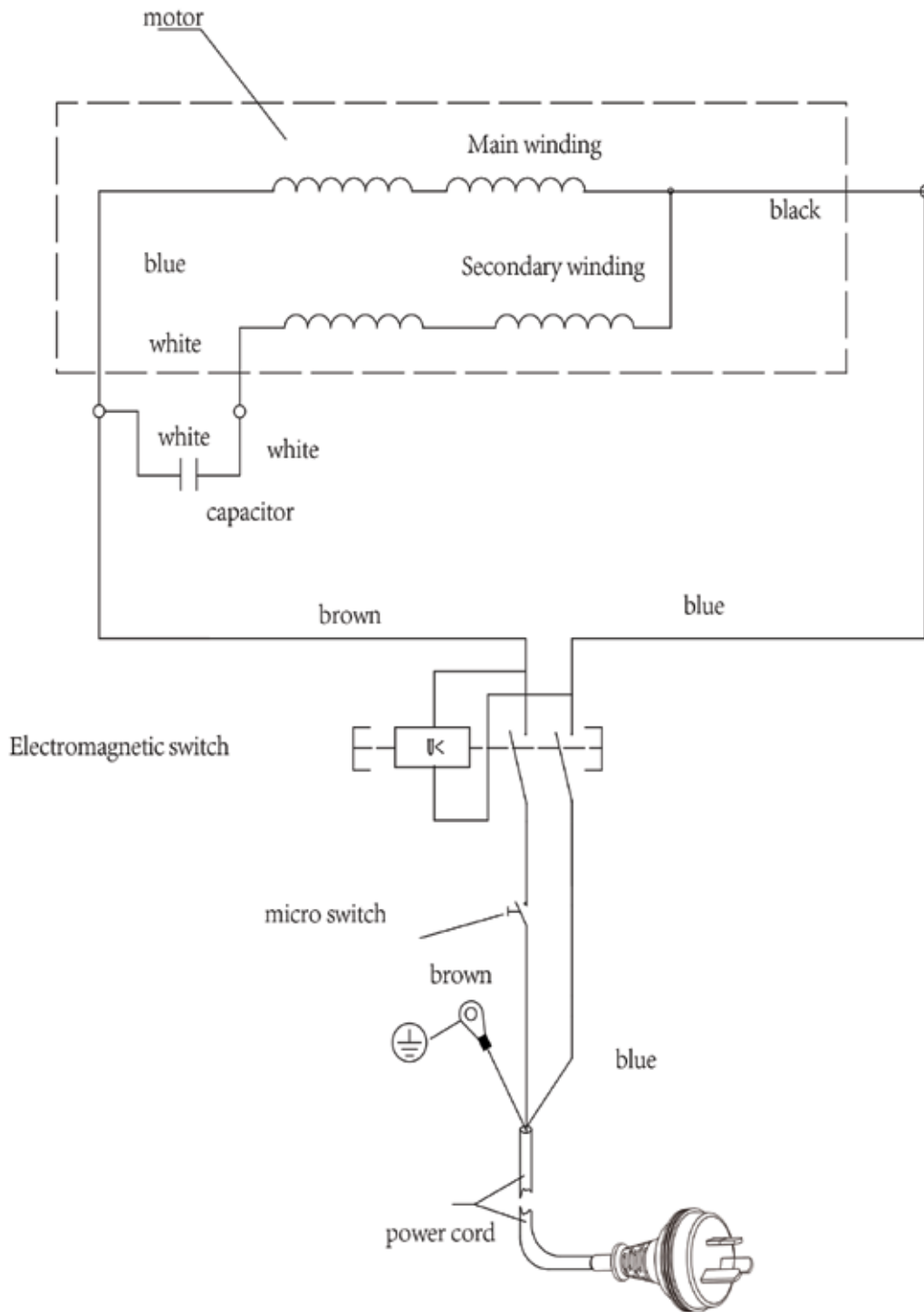

# EXPLODED PARTS DIAGRAM

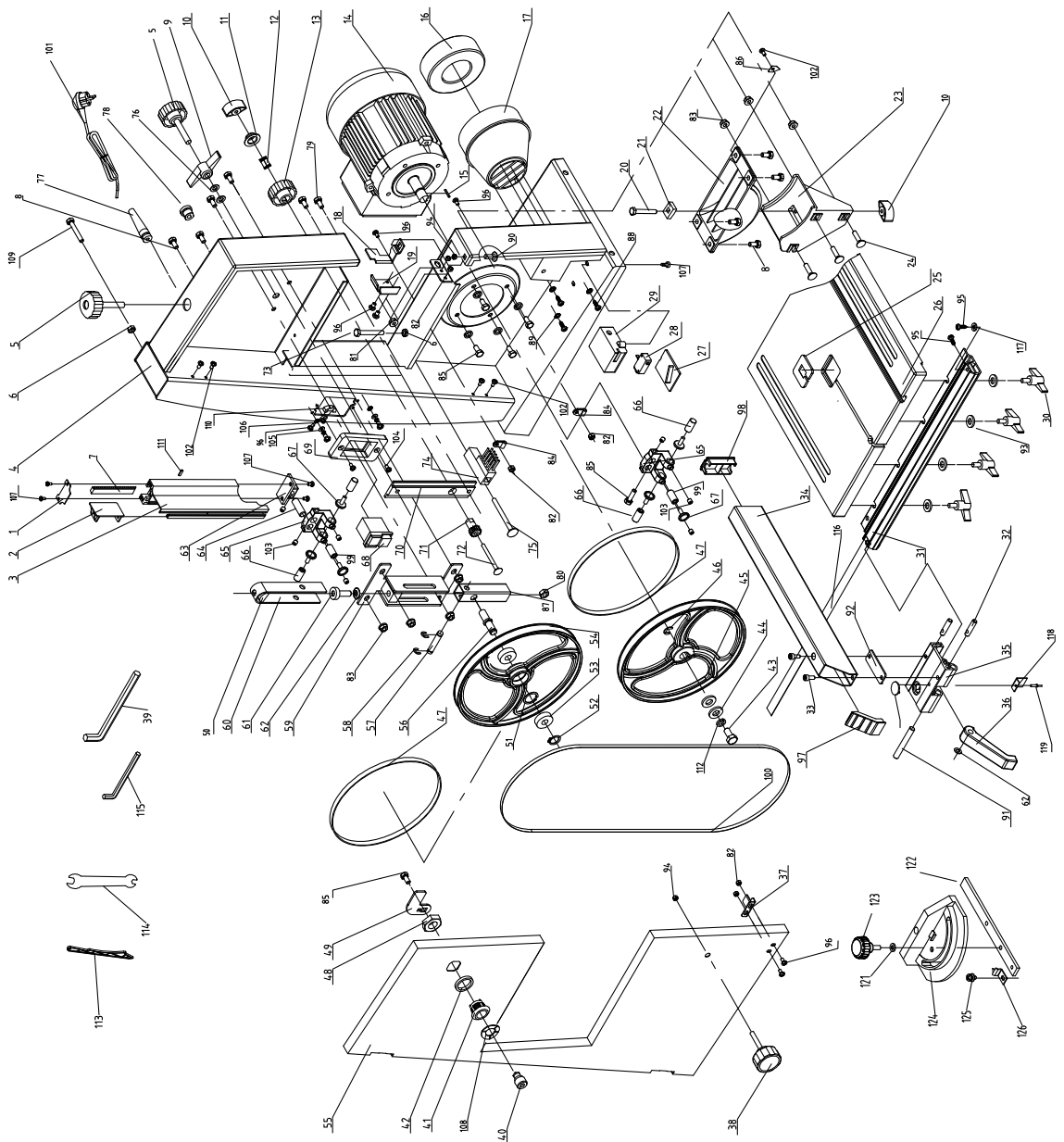

## PARTS LIST

Seq	Description	QTY	Seq	Description	QTY
1	Upper guide slide bar baffle	1	62	Butterfly spring 8	11
2	Slide board	1	63	Upper conductor base	1
3	Upper guide slide bar	1	64	Guide seat connecting shaft	1
4	Saw body	1	65	Upper blade guide support	2
5	Tension handle	2	66	Support shaft 2	4
6	Hex nut M6	1	67	Guide wheel	6
7	Rack	1	68	Electromagnetic switch CK-1	1
8	Hexagon flange bolt M6X12	8	69	Switch board	1
9	Airfoil nut	1	70	Guide block	1
10	Worktable locking knob	2	71	Adjusting gear	1
11	Spring pressing plate	1	72	Half round head square neck bolt M6X57	1
12	Locking spring	1	73	Hexagon headed bolt M6X55	1
13	Adjusting handle	1	74	Brush	1
14	Motor assembly	1	75	Half round head square neck bolt M8X70	1
15	Key 5x15	1	76	Flat washer 8	2
16	Connector	1	77	Cable sheath	1
17	Suction port	1	78	Wire clip 6P4	1
18	Right guard of saw blade	1	79	Hexagon flange bolt M6X6	2
19	Left guard of saw blade	1	80	Hexagon nut M10	1
20	Half round head square neck bolt M6X30	1	81	Hexagon flange nuts M8	1
21	Slider	1	82	Hexagon nut M4	6
22	Table angle frame	1	83	Hexagon flange nuts M6	7
23	Table angle support	1	84	Thread fixing button	2
24	Half round head square neck bolt M6X16	3	85	Hexagon head bolt + Spring washer + flat washer M6X	6
25	Table insert	1	86	Table pointer	1
26	Work table	1	87	Upper wheel seat	1
27	Switch box	1	88	Cross recessed pan head tapping screw ST3.5*9.5	4
28	Switch	1	89	Flat washer 4	4
29	Switch box cover	1	90	M6X10	1
30	Locking knob	4	91	Locking handle shaft	1
31	Baffle slide	1	92	Guiding rule backing plate	1
32	Fence fixing nut	2	93	Flat washer 6	4
33	Hexagon socket head cap screw + flat washer + spring washer M5X12	2	94	Jam nut M6	2
34	Fence	1	95	Cross recessed pan head tapping screw ST3.5*9.5	1
35	Sliding seat	1	96	Cross recessed pan head screw M4X12	8
36	Fence locking knob	1	97	Guiding rule plug	1
37	Switch shrapnel	1	98	Guiding rule front plug	1
38	Door handle	1	99	Support shaft 1	2
39	Inner hexagon spanner S=6	1	100	T8/1490X6X0.35 6TPI	1
40	Lock cylinder	1	101	Power cord	1
41	Lock sleeve	1	102	Screw M4X6	5
42	Lock pad	1	103	Hexagon socket set screw with concave end M6X6	8
43	Hexagon socket head cap screw M6X16(left)	1	104	Cross recessed countersunk head screw M4X12	2
44	Big flat washer 6	2	105	Cross rec. pan head screw, spring washer, flat washer M4X8	2
45	Lower wheel	1	106	External tooth locking pad galvanized 4	2
46	Circlip for shaft 14	1	107	Cross recessed pan head tapping screw ST3.9*12	6
47	Tire	2	108	Wave stop spring washer 10	1
48	Hexagon thin nut M22X1.5	1	109	Hexagon socket head cap screw M6X35	1
49	Tongue slice	1	110	Pull off plate	1
50	Spring nut	1	111	Elastic cylindrical pin 2.5x14	1
51	Internal circlip 26	1	112	Spring washer 6	1
52	Circlip for shaft 9	1	113	Pushing hands	1
53	Ball bearing 6000	2	114	Fork wrench	1
54	Upper wheel	1	115	Inner hexagon spannerS=3	1
55	Door assembly	1	116	Slide scale	1
56	Upper wheel shaft	1	117	Flat washer 4	1
57	Connection shaft	1	118	Guiding rule spring 65Mn	1
58	Washer 6	2	119	Pull rivet 4x6	1
59	Guide plate assembly	1	120	Guiding ruler mirror	1
60	U-shaped support	1	121	Large flat washer φ6	1
61	Butterfly spring shaft	1	122	Miter bar	1
			123	Miter gauge knob	1
			124	Miter gauge	1
			125	Cross rec. pan head screw + spring washer + flat washer	1
			126	Miter gauge pointer	1

# 1 YEAR WARRANTY

## WARRANTY

- A. We warrant that this Carbatec product will be free from defects caused by faulty workmanship or faulty materials for a period of 1 year from date of sale.
- B. This warranty is in addition to other rights and remedies you may have under a law in relation to the goods.
- C. This warranty does not apply in any of the following cases:
- i. Defects arising from:
    1. fair wear and tear;
    2. corrosive atmosphere;
    3. damage or injury caused by deliberate act, lack of care or failure to comply with the recommended care and maintenance for the goods;
    4. improper use of the goods;
    5. alterations or repairs (not made by us) to the goods;
  - ii. defects arising from an event outside of our control such as fire, flood, earthquake or other natural calamity, motor vehicle or other accident, strike, civil unrest, terrorism or war;
  - iii. to accessory items such as after-market jigs, accessories or other items which are not sold or serviced by us and which are not sold with or were not included with the main unit purchased; or
  - iv. to wearable parts such as drive belts/shafts, bearings, bandsaw tyres, motor brushes, blades or abrasive belts/discs or other cutting or machining implements.
  - v. damage caused to any electrical component, where connected to a power supply outside the country for which it was designed (namely Australia or New Zealand).
- D. If this warranty applies and you have complied with the procedure below for making a claim, we will, at our election, either repair the goods (or those parts of the goods recognised as defective) or will provide a replacement within a reasonable time at our expense.
- E. If this warranty applies, the procedure for making a claim is:
- i. you must contact us by email;
  - ii. you must include in the email the following information:
    1. a copy of the order or receipt for the goods;
    2. the serial or batch number printed on the machinery manufacturing plate; and
    3. a detailed description of the fault and how and when it arose; and
    4. If the fault is a type covered by this warranty, we will then make arrangements with you for the return of the goods to us (for repair or replacement) at our cost using our transport providers or we may decide to attend at your premises to repair or replace the goods.
- F. Our liability (and that of our resellers) under this warranty is wholly limited to repair or replacement of the goods (or those parts of the goods recognised as defective) in accordance with the procedure above and you have no right to other compensation, costs or damages under this warranty. But this does not mean that you may not have other rights under a law in relation to the goods.
- G. If following our inspection of goods returned by you under this warranty it is found that this warranty does not apply and you are not otherwise entitled to repair or replacement by us, you must, if requested by us, reimburse our costs including parts, labour and freight.
- H. This warranty is not transferable and only the person who purchased the goods may make a claim.
- Where the goods have been exported outside Australia or New Zealand, the Company may not require the Purchaser to return any allegedly faulty or defective Product for evaluation. However, the Company has the right to request the return for evaluation at purchasers cost.

## STATUTORY NOTICE

Our goods come with guarantees that cannot be excluded under the Australian Consumer Law. You are entitled to a replacement or refund for a major failure and for compensation for any other reasonably foreseeable loss or damage. You are also entitled to have the goods repaired or replaced if the goods fail to be of acceptable quality and the failure does not amount to a major failure.





**Carbatec Pty Ltd**

**E** [info@carbatec.com.au](mailto:info@carbatec.com.au)

**AU** 1800 658 111

**NZ** 0800 444 329

128 Ingleston Road, Wakerley,  
Queensland Australia 4154

ABN 84 010 706 242

**CARBATEC.COM.AU**

**carbatec®**

**1** YEAR  
WARRANTY